

# Właz okrągły B16 550x310 mm

Rectangular manhole door with outwardly vertical opening for concrete tanks.  
Working pressure: +2,0 Bar (without PED)

Prostokątne drzwi włazowe z pionowym otworem na zewnątrz do zbiorników betonowych.  
Ciśnienie robocze: +2,0 Bar (bez PED)

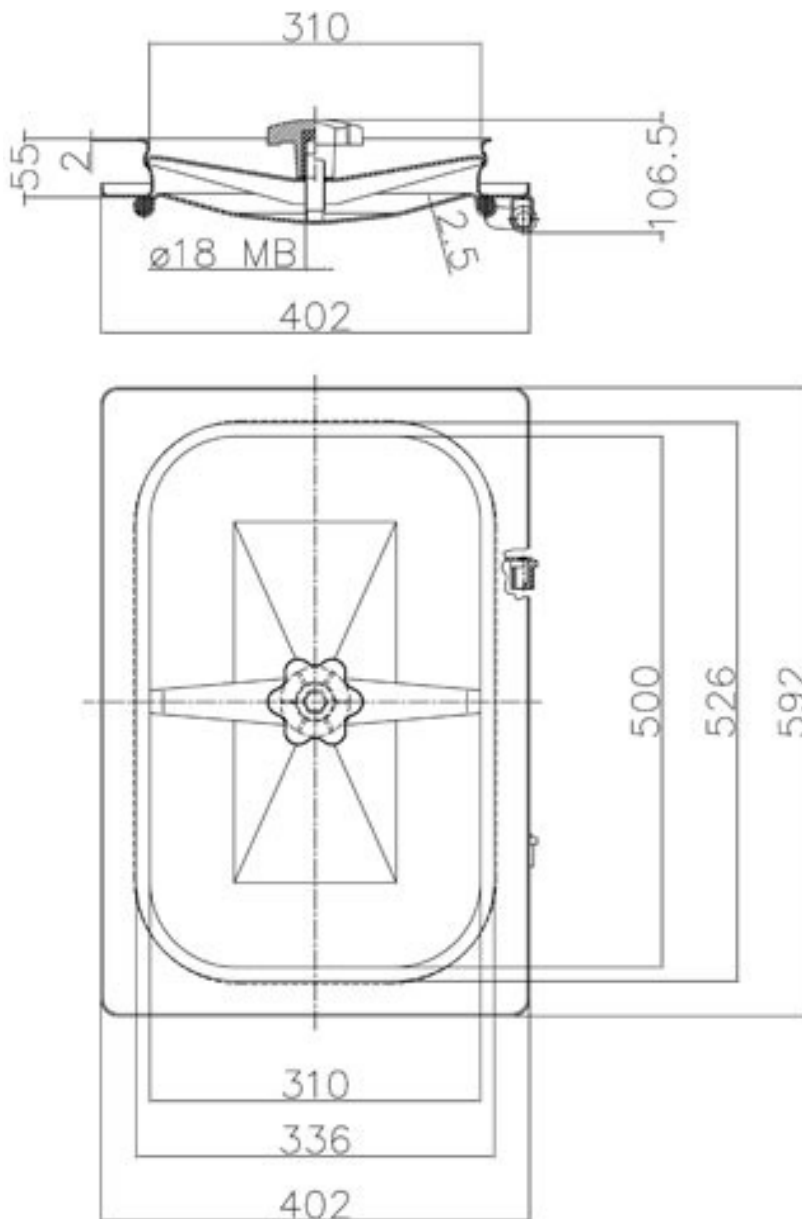

Available gaskets	
TYPE OF MATERIAL	TEMPERATURE
EPDM	-35°/+110°
NITRILE (NBR)	-15°/+110°
SILICON	-35°/+200°
VITON	-20°/+200°