

NEW



MOD. T1/150

Ø 154 mm - Esterno telaio / External frame

Chiusino circolare con apertura a ribaltamento

Di serie con guarnizione in EPDM G/T150 e volantino in nylon blu MEC 60. Guarnizione sul telaio. Coperchio elettrolucidato. Telaio decapato. AISI 304L - 14307 / AISI 316L - 14404 (Le parti non a contatto col liquido sono in Aisi 304)

Round manhole cover with back-side opening

Standard with EPDM gasket G/T150 and nylon handwheel MEC/60. Gasket on the frame. Lid: electropolished. Frame: pickled. AISI 304L - 14307 / AISI 316L - 14404 (All the non-wetted parts are in AISI 304)

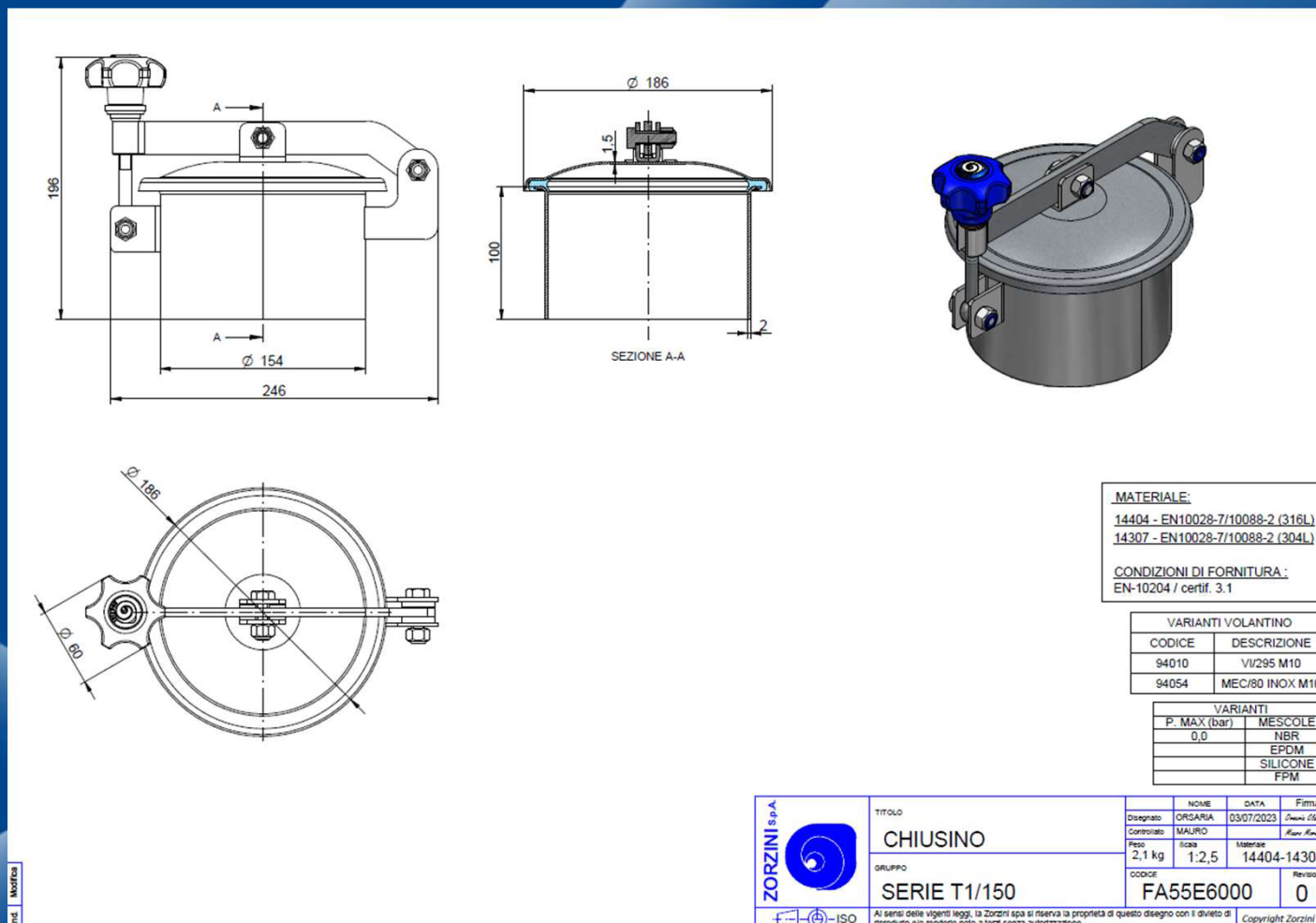

Disponibile dal : 01/01/2025
Available from : 01/01/2025